

THERMALLY BROKEN 100mm FrontGLAZE™ FRAMING

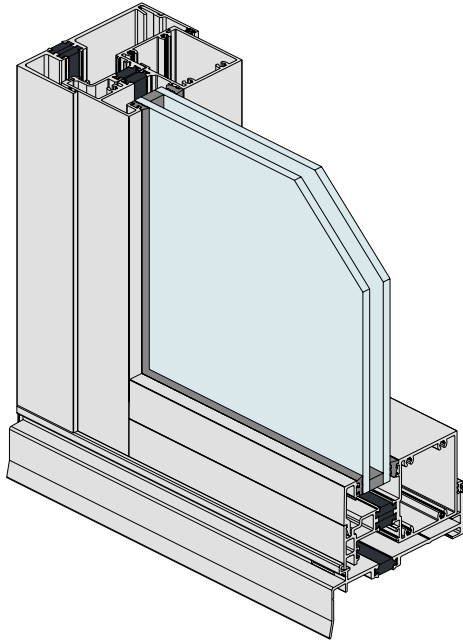

KEY FEATURES

- Incorporating ThermalHEART® technology, Series 824 delivers excellent thermal performance and is ideal for commercial and high-end residential applications.
- The 28mm deep glazing pocket caters for glass installation and 12mm bite as required by IGU manufacturers.
- Reinforced tall glazing bead at sill tolerates high negative wind loads.
- Available as internally glazed or externally glazed.
- True captive glazing wedge allows reglazing from inside – ideal in elevated applications and offers increased security.
- External wet top silicone glazing also available.
- Glazing wedges are recessed for a clean appearance.
- Wide range of thermally broken sub-frames, including sub-sills with integrated nailing fin ideal for residential installations.
- Internal and external swing hinged door thresholds.
- 50mm thick doors designed to accept wide backset locks.

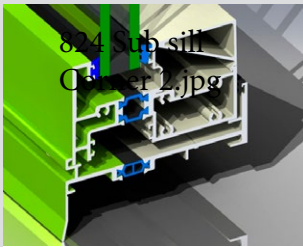

Sub-sill designed to support heavy double glazed frames and maintain the thermal break – dual colour option. We offer FrontGLAZE™ in both internal and external glazing.

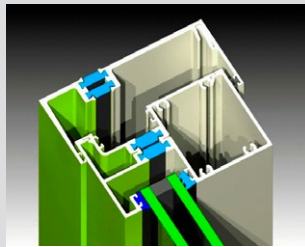

Sub-jamb available to make installation easier. The sub-jamb has pressure bead on the inner face.

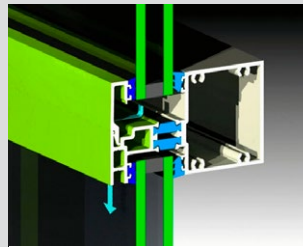

Designed to accept 24mm IGUs. Glazing pocket offers the required 12mm glass bite on IGUs. A variety of pocket closer extrusions are available should thinner glass be required.

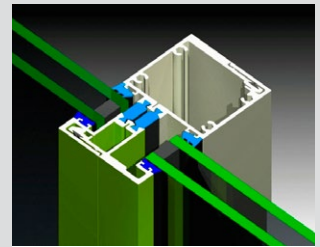

We offer both snap-together and expansion mullions. We recommend expansion mullions on long runs of framing (over 6m).

ENERGY

Max Panel Height
Various

Max Panel Width
Various

Max Glass Thickness
28mm

Frame Depth
100mm

ENERGY

UW Range
1.7-3.1

SHGC Range
0.17-0.67

WEATHER

Maximum Water
600 Pa.

ACOUSTICS

This product has not been acoustics tested. AWS anticipates this product's acoustic performance will be in-line with Series 804.



BAL-40 compliance may limit glass options. Maximum glass size for BAL-40 products is 4.5m2.

elevatealuminium.com.au/824