

DESIGNER SERIES ThermalHEART® | SERIES 730
THERMALLY BROKEN BI-FOLD DOOR

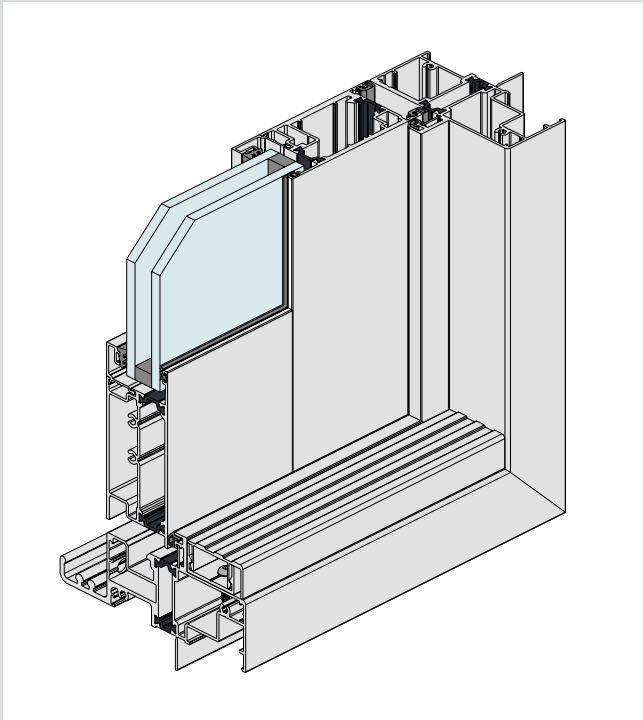

KEY FEATURES

- Series 730 incorporates ThermalHEART® technology. ThermalHEART® systems perform up to 32% better than traditional aluminium windows and doors.
- Series 730 is a bottom rolling bi-fold system ideal for residential applications. Can be fitted with optional highlights.
- This bi-fold door has been tested for compliance with the relevant Australian Standards and achieved a high water resistance of 380Pa, making the product suitable for most residential applications.
- Low air infiltration suitable for air-conditioned buildings.
- Sharp square external glazing beads are standard.
- 100mm frame and transom have a soft 2mm internal radius.
- Doors can be fitted with a variety of custom lever and bi-fold activator sets (ICON™ or MIRO™) with Lever Compression Lock (LCL) motor as standard.
- ThermalHEART® will accept insulating glass units up to 32mm thick. The typical IGU thickness is 24mm.



Doors are fitted with heavy duty bottom rolling gear running on double tracks, ideal for supporting the weights of heavy double glazed door panels.

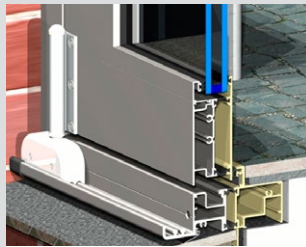

Optional 316 stainless steel roller cowling – designed for coastal applications. Bottom rollers allow us to have heavy door panels as the weight is supported by the sill as well as the option of highlights being fitted above.



We offer 4-point lever compression locking as standard. This ensures high performance seals and improves air infiltration resistance. ICON™ stainless steel furniture shown above.

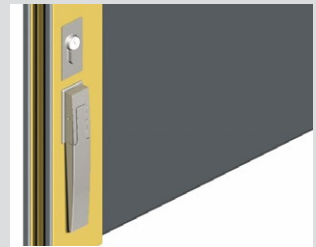

The bi-fold activator secures the folding panels tight into the frame when closed. By turning the level 90° shoot bolts top and bottom are retracted to allow panels to open. We offer this furniture in two custom designs.

GENERAL

Max Panel Height*
2600mm

Max Panel Width*
900mm

Max Glass Thickness
32mm

Frame Depth
100mm

ENERGY

UW Range
2.3-4.9

SHGC Range
0.13-0.48

WEATHER

Maximum Water
380 Pa.

ACOUSTICS

19mm Insulated
Glass Unit
Rw 33

Acoustic Results Based on
Series 548 Hinge Door



*Dimensions subject to individual site conditions.
BAL-40 compliance may limit glass options. Maximum glass size for BAL-40 products is 4.5m2.

vantagealuminium.com.au/730