

# THERMALLY BROKEN HINGED DOOR

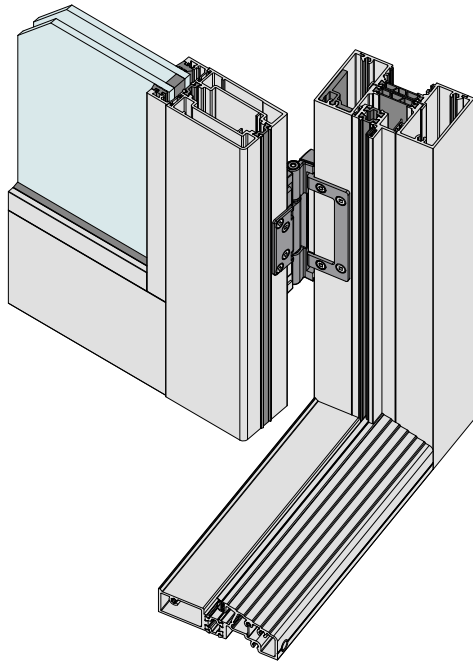

## KEY FEATURES

- Incorporating ThermalHEART® technology, Series 852 delivers excellent thermal performance and is ideal for commercial and high-end residential applications.
- Incorporates fully beaded 50mm thick heavy duty door stiles and rails designed to accept 28mm IGUs.
- Door stiles have been designed to accept wide backset (34mm and 38mm) locks. The greater the backset, the easier it is to access the key.
- Double glazed hinged doors will be heavy and for this reason we offer an adjustable heavy duty hinge.
- Captive co-extruded glazing wedge option (illustrated) reduces the chance of vandalism.
- Available as hinged or pivot configuration with various threshold options.
- Top and bottom rails are secured to stiles with heavy duty spigot fixed to thick backing plate with high tensile bolts.

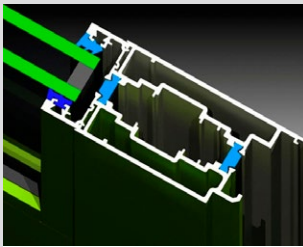

Series 852 doors have several wide door stiles to choose from, including true French meeting stiles.

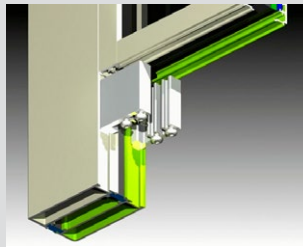

Commercial doors are only as good as the joinery system. Series 852 doors have custom extruded aluminium spigots and backing plates that ensure the joint between the stiles and rails stays tight.

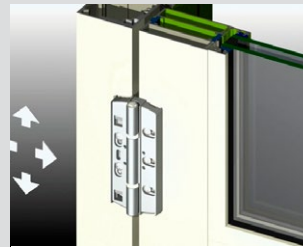

The doors have been designed to accept a heavy adjustable hinge. Screw cover plates removed to show the adjustment screws.

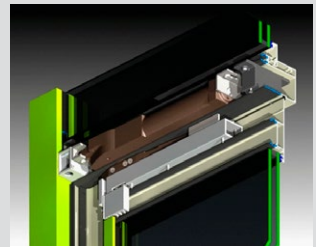

Custom thermally broken head and transom to accept COC cover and doors.

### GENERAL

**Max Panel Height**  
3000mm

**Max Panel Width**  
1000mm

**Max Glass Thickness**  
28mm

**Frame Depth**  
50mm

### ENERGY

**UW Range**  
2.5-3.5

**SHGC Range**  
0.14-0.45

### WEATHER

Weather performance of this system will depend upon selected framing, configuration and sill. For more information contact AWS.

### ACOUSTICS

This product has not been acoustics tested.



BAL-40 compliance may limit glass options. Maximum glass size for BAL-40 products is 4.5m2.

[elevatealuminium.com.au/852H](http://elevatealuminium.com.au/852H)